

# MODULAR WORKSTATIONS

## COMPONENTS

**A** 1524mm Uprights  
2 of

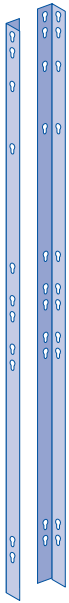

**B** 915mm Uprights  
2 of



**C** Front & rear beams  
total 4 of

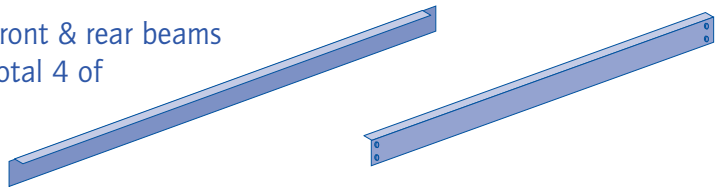

**D** Upper side beams  
2 of

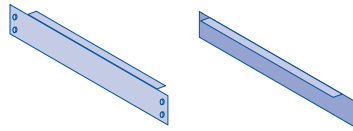

**E** Lower side beams  
2 of

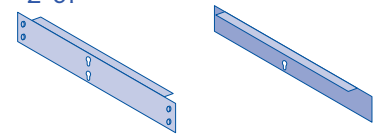

**F** Upper shelf support  
(front to back) 1 of

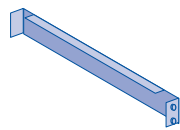

**G** Lower shelf support  
(left to right) 1 of

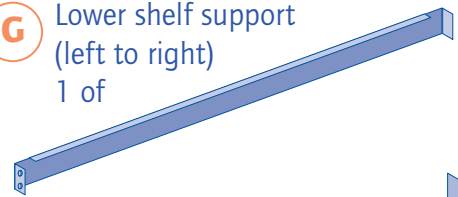

**H** Upper cantilever  
shelf support



**J** Rebated MDF  
work surface

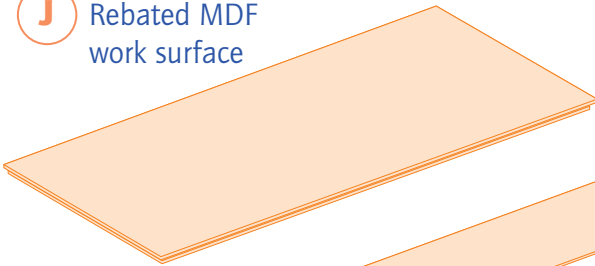

**I** Back panel

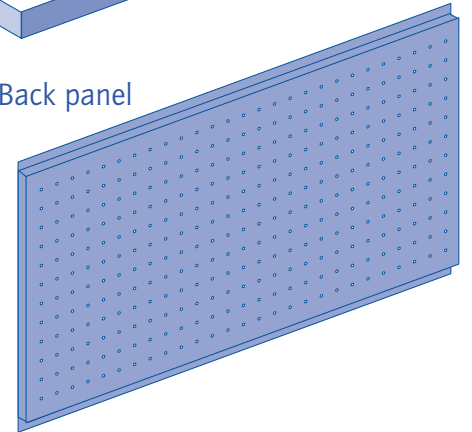

**K** MDF bottom  
half shelf



**L** MDF upper  
shelf



**P** Drawer side beams  
2 of

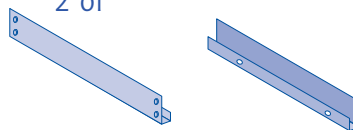

**T** 2 door cupboard

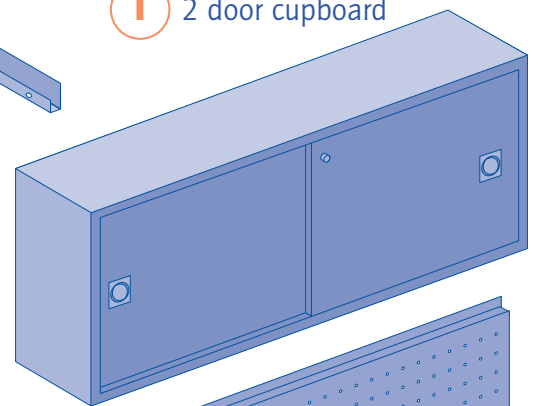

**M** Plastic feet



**N** Plastic caps



**Q** MDF drawer  
base

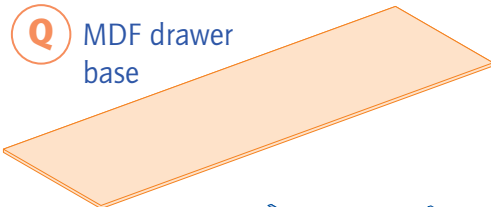

**S** M4 Nuts and  
bolts

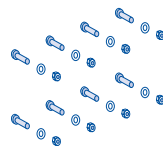

**R** Drawer runners

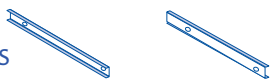

**W** Solid drawer

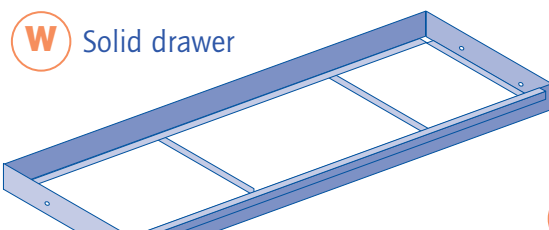

**U** M5 Screws



**V** Peawall panel

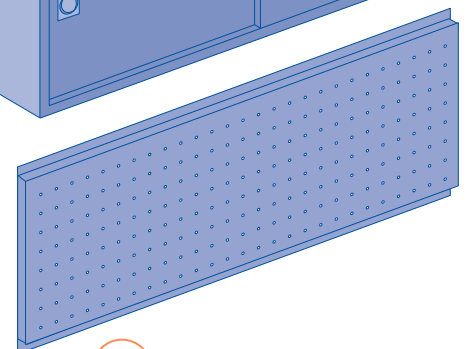

IMPORTANT - ASSEMBLY INSTRUCTIONS

# MODULAR WORKSTATIONS

**IMPORTANT - ASSEMBLY INSTRUCTIONS**

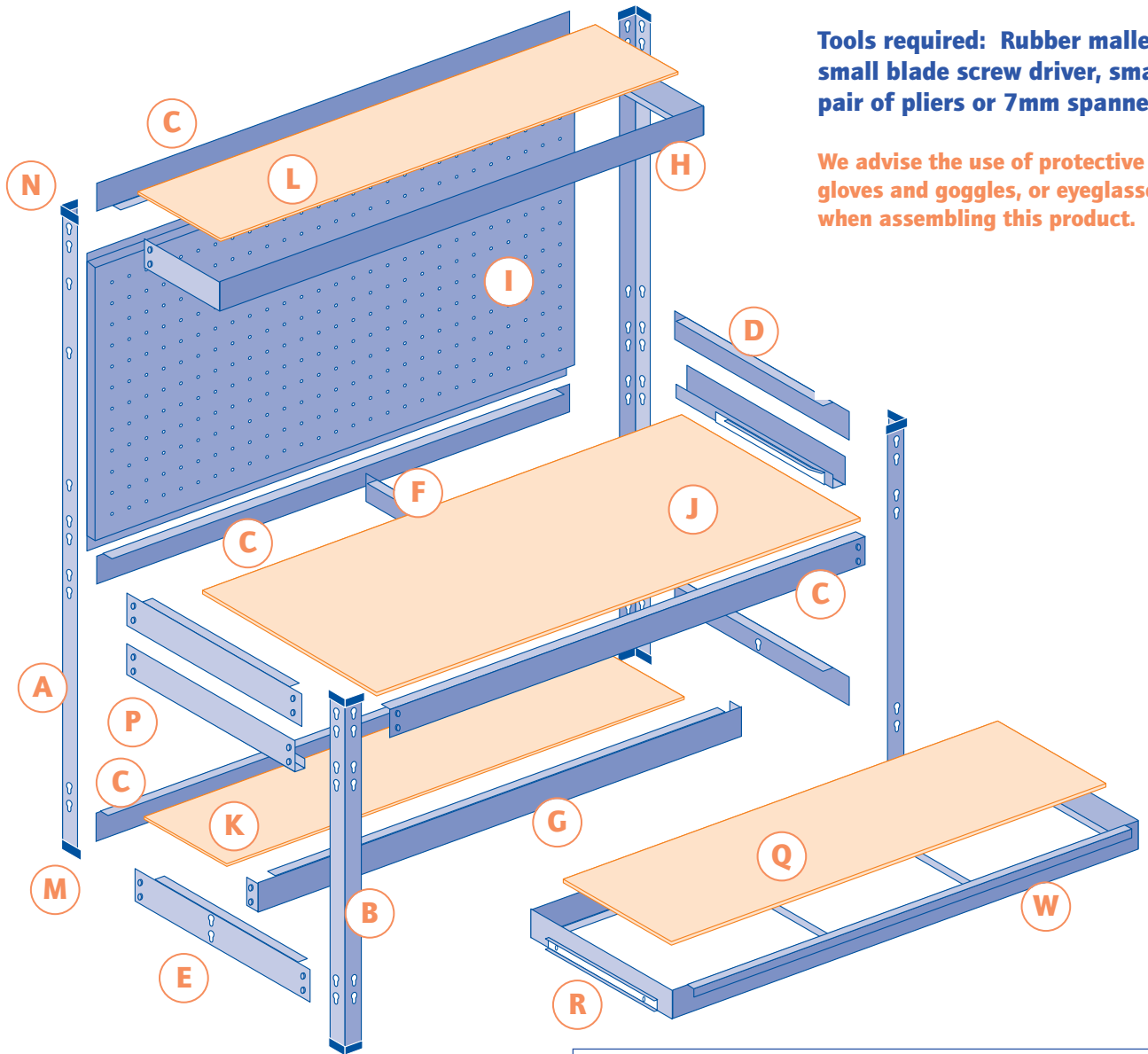

**Tools required:** Rubber mallet, small blade screw driver, small pair of pliers or 7mm spanner.

We advise the use of protective gloves and goggles, or eyeglasses when assembling this product.

- 1 Assemble side steel first - A, B, D, E, and P, if a drawer is fitted (Fit feet).
- 2 Add front and rear beam C (4 off).
- 3 Add shelf support F and G.
- 4 Insert back panel I and capture behind the upper raised beam.
- 5 Add work surface J, under bottom lip of back panel I.
- 6 Add upper cantilever shelf H and remaining MDF shelves L and K.
- 7 If drawers are fitted, attach runner R, to drawer W with 4 screws S (see illustration).
- 8 Fit drawer to unit using 4 screws S (see illustration).
- 9 Fit drawer base Q.
- 10 For the 'Compact Station' version with cupboard - there is no upper rear beam C or cantilever shelf assembly H and L. After instruction 3 attach the cupboard T to the rear uprights A using screws U. Continue then with instruction 5.

## Fitting Drawer

- 1 First fit runners to support beams P, using screws S

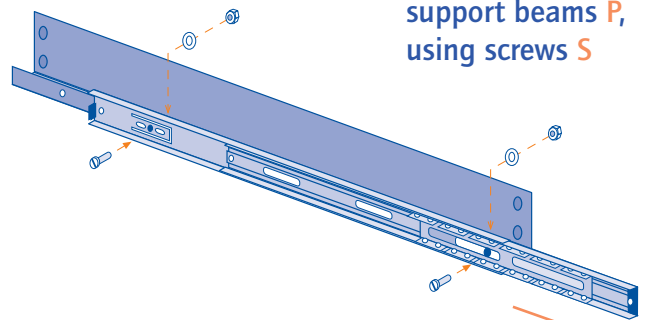

- 2 Fit runners to drawer sides using screws S

